









Used machine available from Weinig UK

Stock reference

WUK1392-1

-  Planers /Moulders
-  Ripsaws
-  Band Resaws
-  Scanner Systems
-  Crosscut Saws
-  Finger Jointing Lines
-  Tool Grinders/Tooling
-  Edgebanders
-  CNC Machining Centres
-  Horizontal Beam Saws
-  Vertical Panel Saw

Machine model:	Powermat 700-018	Serial number E. number	123.381
Availability:	Immediate	Year of Manu:	2016
Warranty offered:	6 months parts and labour		
Condition of sale:	Perfect working order		
Installation:	Installation included		
<p>SALES PRICE: £88,150.00 + vat (subject to prior sale includes HIAB vehicle delivery to site UK mainland)</p>			

An absolute gem of a machine with a great specification!



Michael Weinig (UK) Limited

5 Blacklands Way, Abingdon Business Park, Abingdon, Oxon OX14 1DY. Tel: (01235) 557600. Website: www.weinig.com
 Sales and Accounts: Email: sales@weinig.co.uk. Servicing and Spares: Email: service@weinig.co.uk

Co. Reg. No. 1617754. Registered Office Address: 5 Blacklands Way, Abingdon Business Park, Abingdon, Oxon OX14 1DY.
 Vat Reg. No. GB 348 5661 25.

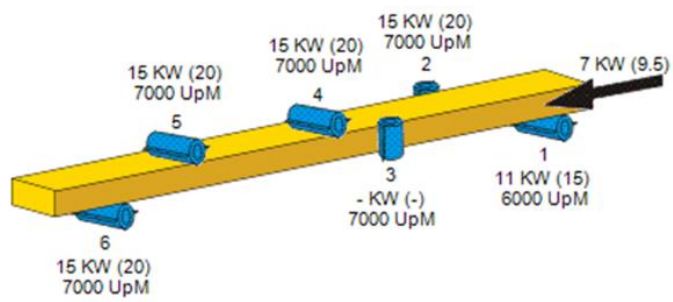

Tool arrangement no. 018



Operating concept Comfort Set

A unique operating concept with scales and clear measurements located at all relevant setting points in the machine. All setup requirements can be performed either wrench-free or with the assistance of only two hand tools. This results in ergonomic and safe setup for the operator, short setup times and high quality of the end product.

Technical data

Working width 20 – 260 mm
 (with tool cutting circle 93 - 125 mm)
 speed max. 7000 rpm.
 Incl. air pad system in the machine table.

Working height (with tool cutting circle 93 - 125 mm) 10 – 160 mm

1. spindle

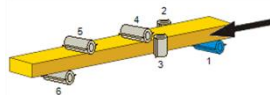

First horizontal bottom spindle

Motor 11 KW (15 HP)



PowerLock - tool holder

Revolution speed 6000 rpm

Tool cutting circle 125 - 145 m

Setting range axial 17 mm



Electronical digital display for radial adjustment
Advantage
- Exact and quick positioning of spindle

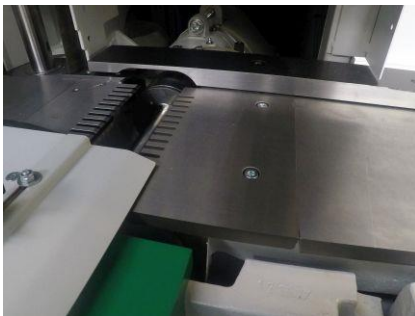

MarathonCoating for table insert, in front of
1st bottom spindle

2. spindle

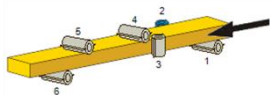

First right vertical spindle

Joint motor for both vertical spindles 15 KW (20 HP)

PowerLock - tool holder
Advantage
- Quicker and safe tool change

Revolutions 7000 rpm

Maximum profile depth 35 mm

Setting range axial 55 mm

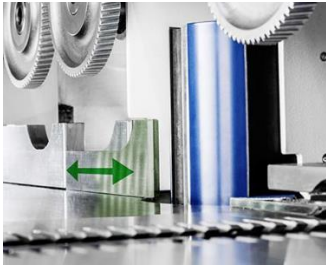

Fence lip after the right vertical spindle with quick adjustment

Your advantages:

- Reduced setup time due to quick positioning to the tool diameter

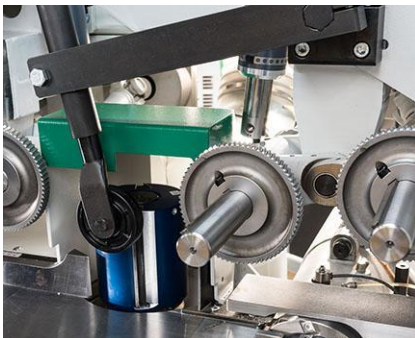

Pressure roller from above located opposite the right spindle pivoting out of the way, spring loaded.

- Safe guidance of workpieces near the right spindle
- Good accessibility for tool change by pivoting out of the way

3. spindle

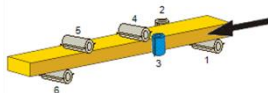

First left vertical spindle

Joint motor for both vertical spindles

PowerLock - tool holder

Advantage

- Quicker and safe tool change

Revolutions 7000 rpm

Maximum profile depth 35 mm

Setting range axial 55 mm



Quick disconnect dust extraction hose

Your advantage:

- Reduced setup time and greater safety due to improved access to the left spindle and the area in front of it



Two lateral roller pressure in front of left spindle revolving and spring-mounted

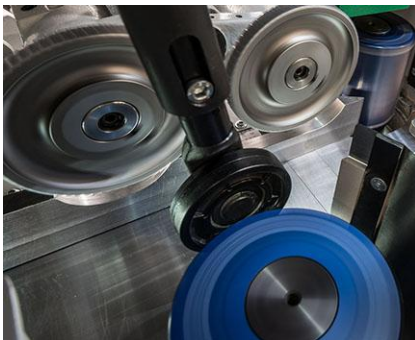

Pressure roller from above located opposite the left spindle pivoting out of the way, spring loaded.

Advantage

- Safe guidance of workpieces near the left spindle
 - Good accessibility for tool change by pivoting out of the way
-

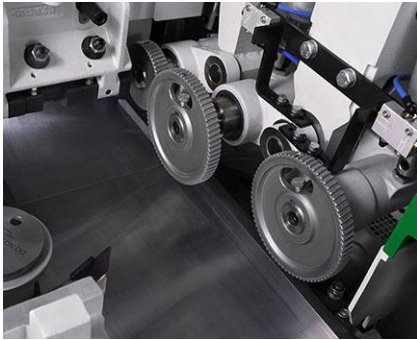

Setting range of the feed rollers opposite left spindle,
axial 35 mm



Extension of the pendulum arbor opposite the
left spindles to 150 mm



Radial CNC-controlled adjustment and positioning of tool holders in combination
with Memory - Function or the PowerCom.

4. spindle

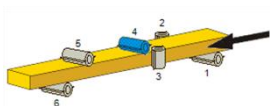

First horizontal top spindle

Motor 15 KW (20 HP)

PowerLock - tool holder
Advantage
- Quicker and safe tool change

Revolutions 7000 rpm

Maximum profile depth 35 mm

Setting range axial 40 mm



Split pressure shoe in front of top spindle with horizontal plane of adjustment to the tool cutting circle and receding from the tool, pneumatic.

Your advantages:

- Precise positioning to the tool diameter for ideal control of workpieces
 - No need to change the chipbreaker shoe
-

Pressure shoe in front of and guide after top spindle with electronic digital displays integrated in Memory function or PowerCom.



Radial CNC-controlled adjustment and positioning of tool holders in combination with Memory - Function or the PowerCom.

5. spindle

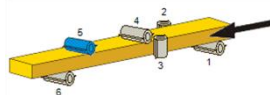

Second horizontal top spindle

Motor 15 KW (20 HP)

PowerLock - tool holder
 Advantage
 - Quicker and safe tool change

Revolutions 7000 rpm

Maximum profile depth 35 mm

Setting range axial 40 mm



Split pressure shoe in front of top spindle with horizontal plane of adjustment to the tool cutting circle and receding from the tool, pneumatic.

Your advantages:

- Precise positioning to the tool diameter for ideal control of workpieces
- No need to change the chipbreaker shoe

Pressure shoe in front of and guide after top spindle with electronic digital displays integrated in Memory function or PowerCom.



Guide for exchangeable counter profiles after top spindle, laterally movable

Top spindle prepared for subsequent attachment of the cassette system.



Radial CNC-controlled adjustment and positioning of tool holders in combination with Memory - Function or the PowerCom.

6. spindle

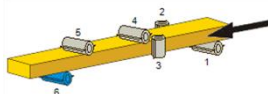

Second horizontal bottom spindle

Motor 15 KW (20 HP)

PowerLock - tool holder
Advantage
- Quicker and safe tool change

Revolutions 7000 rpm

Adjustment range axial 40 mm

Feed system

Feed speed electronically variable incl.brake 5 – 40 m/min

Motor 7 KW (9.5 HP)



All feed rollers with quick clamping

Your advantages:

- Quick positioning of feed roller tracking
 - Quicker exchange of feed rollers
-

Durofer pointed tooth rollers self-cleaning with depth limitation

First feed roller with free-wheel gear, in lieu of the standard roller

CNC-controlled adjustment and positioning of feed up/down in combination with Memory - Function or the PowerCom.

Machine electric

Operating voltage 400 Volt
(Range between 380 - 420 Volt), 50 Cycles

Machine base, tables and fences

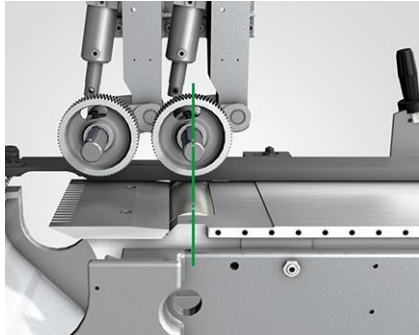

Short infeed table 1.2 m long with 2 driven rollers above the table, 1 driven, serrated roller in the table, incl. lateral pressure roller, spring-mounted.

Advantage

- Robust machine infeed for reliable feeding

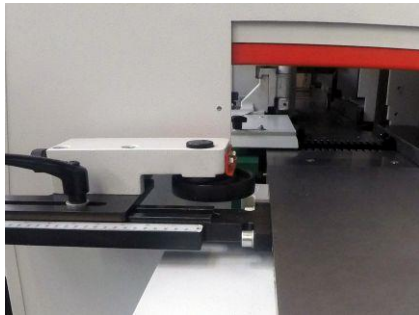

Lateral pressure roller at the infeed table, spring-mounted

Advantage

- Correct guidance of long workpieces at the edge jointing fence

MarathonCoating for machine tables and fences (excluding infeed table and special table plates). Special coating for table plates and fences to prevent high wear. Recommended for the production of abrasive materials such as; tropical hardwoods, MDF and plywood.

Manual lubricant pump to remove resin from machine table, incl. 5 liters lubricant.

One driven steel roller in the machine table, hardened

One driven rubber roller in the outfeed table, respectively in front of universal spindle (if existing), spring - mounted.

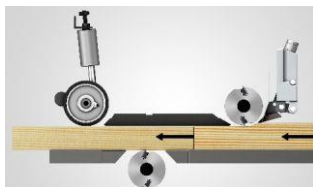

Back-Pressure System

Optimised workpiece extraction when the feed is pushed to eliminate gaps between the workpieces and improve the surface quality.

Advantage

- High surface quality when the feed is pushed
- Extraction of last workpiece from the machine

Pressure elements and guides

Guiding fences after left spindle 6 mm thick with manual adjustments for width and height.

Machine operation



PowerCom Plus

- Profile and tool data management software

Remote support / maintenance (VPN)

Lubrication points for axial spindle adjustment

Central position of lubrication points at the front side of the machine

Safety and noise protection

Machine with spindle brakes
Electromagnetic interlocking of the safety enclosure
(the machine can only be opened after the standstill of the spindles, approx. 15 seconds) and interior light inside the safety enclosure.

Standard enclosure

When the safety hood is lifted the spindles and feed are automatically switched off. In the CE execution the safety enclosure cannot be opened during automatic operation.

Package Interior Light Plus
to improve the interior illumination of the machine.
Three additional interior lights in the safety hood
Advantage
- Improved illumination of the inside of the machine
